

Metal Garden Shed

OWNER'S MANUAL

Instructions for Assembly

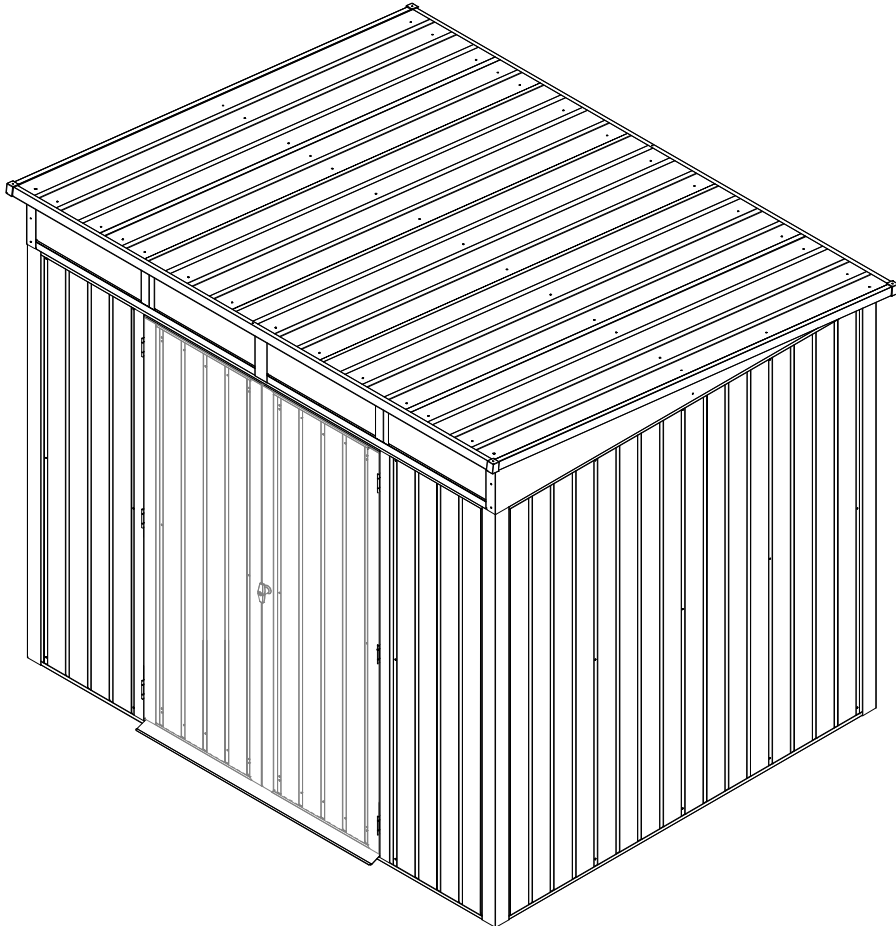

T-PS0608K

Requires two people and takes about 6 hours for Installation.

Quick & Easy Assembly

Ridge Reinforced Walls

Available in Various Sizes

BEFORE YOU START

Owner's Manual

Prior to installation, it is important that you contact your local government authority to determine if building approval is required. Study and understand this owner's manual. Important information and helpful tips will make your construction easier and more enjoyable.

Assembly instructions

Instructions are supplied in this manual and contain all appropriate information for your building model. Review all instructions before you begin. During assembly, follow the step sequence carefully for correct results. Please be aware: **this unit takes two people about 6 hours to complete.**

Parts

Check to be sure that you have all the necessary parts for the building.

Separate contents of the carton by the part number while reviewing parts list.

Familiarize yourself with the hardware and fasteners for easier use during construction. These are packaged within the carton. Note that extra fasteners have been supplied for your convenience.

TOOLS MAY REQUIRED

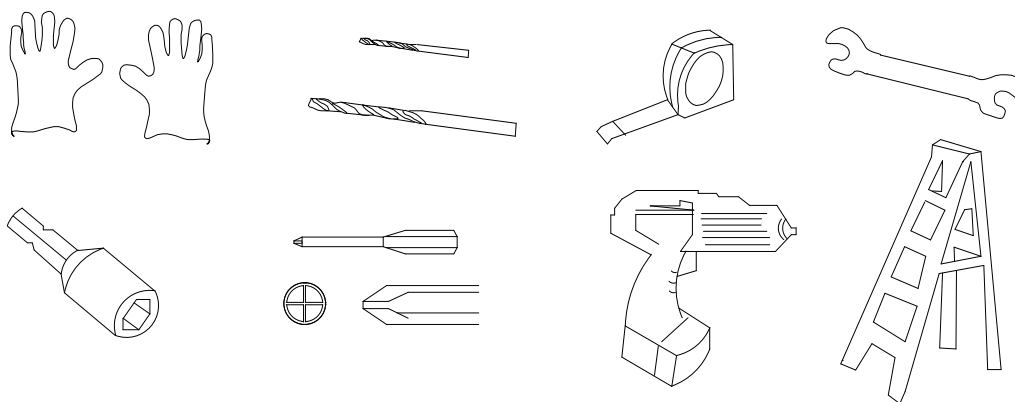

Use heavy duty gloves when handling steel sheets and flashing

PLAN AHEAD

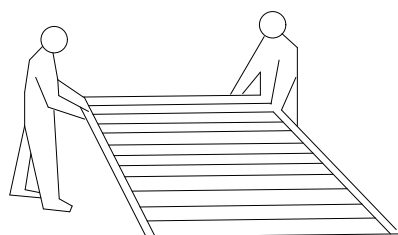

It requires two people about 6 hours to complete installation.

Watch the weather:

Please be sure the day you select for installation is dry and calm.

DO NOT attempt to assemble your shed in windy weather because of risk of damage to panels, or personal injury. Be careful of wet or muddy ground.

Teamwork:

Whenever possible, two or more people should work together to assemble the building. One person can position parts or panels while the other is able to handle the fasteners and the tools.

PLAN AHEAD

Site Selection

- Avoid overhanging trees as much as possible as leaves will make regular cleaning necessary and broken branches are a potential hazard.
- Small trees, bushes or fences nearby can be helpful, acting as a wind break.

Site Preparation

The site must be prepared so that the base of the shed is level all round and checking with a spirit level is required.

The base can be constructed by treated timber or concrete, in order to stop the moisture getting into the shed. **The shed is not designed to be built onto lawn directly.** Also the ground will get muddy during rainy days.

If a concrete pad is made, it is important that this slopes towards the edges to prevent water ingress.

























Time must be allowed for any concrete or cement to dry before building the shed on top.



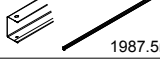











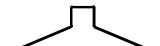
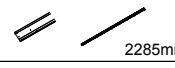





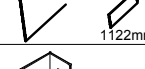

Bases can also be constructed from bricks, blocks, or mounted on a concrete pad.

The bricks or blocks should be cemented onto firm and level concrete footings and the greenhouse frame drilled and screwed to the base.

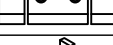
IMPORTANT NOTES:

- Find someone to help you: it is much easier with someone to hold parts, pass tools ect. Also some steps require two people to lift structures together. This is not very heavy work so would suit most able-bodied people.
- Allow plenty of time: rushing often causes errors and the re-doing of incorrect assemblies. If you have never built a shed before, it can take most of a day to carefully complete the construction.
- Have the right tools to hand.
- Safety clothing as recommended in the 'Tools' section.
- Ideally lay out the parts and check that all are present before commencing construction. Lay on cloths or plastic sheets if there is any risk of scratching the parts.
- Tighten all nuts carefully, being sure not to miss any. Check the frame is square and using a spirit level to check that it is upright.

NO.	PART	Qty.
1	 2208mm	2
1-1	 2208mm	2
2	 1780mm	2
2-1	 1780mm	2
7	 1750mm	8
4	 1750mm	2
30	 572mm	4
31	 1701mm	1
32	 1701mm	1
33	 1701mm	1
34	 1701mm	1
40	 643mm	2
41	 643mm	2
6	 1150mm	1
13	 1755mm	4
13-1	 1755mm	4
21L	 1	1
21R	 1	1
17-2	 1987.5mm	2
20	 1	1
19	 1	1
22	 2	2
12L	 1379mm	1
12R	 1379mm	1
10	 2372mm	1

NO.	PART	Qty.
14L	 1144mm	1
14R	 1144mm	1
17	 2372mm	1
29	 4	4
29-1	 4	4
5	 1150mm	1
11	 2285mm	1
9	 2290mm	1
B1	 128mm	2
P1	 1750mm	15
D1	 1700.5mm	2
P2	 1988.5mm	2
P3	 1988.5mm	3
P4	 1988.5mm	1
P5	 1122mm	2
GC	 4	4
GS	 2	2
H2	 2	2
B6	 6	6
GB	 1	1
F1	 360	360
F2	 40	40
F3	 28	28
S2	 100	100
S3	 216	216

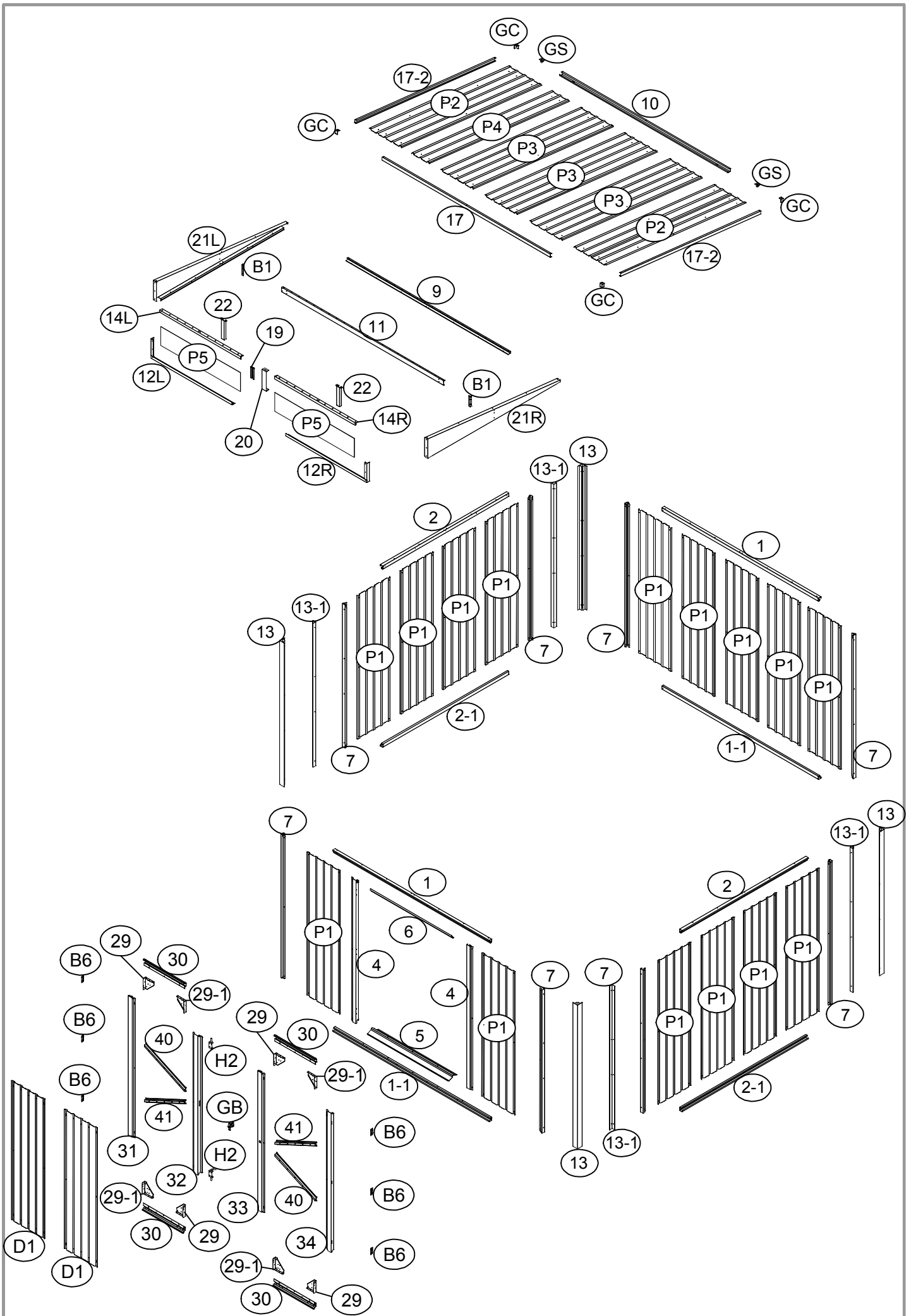

ASSEMBLY OVERVIEW

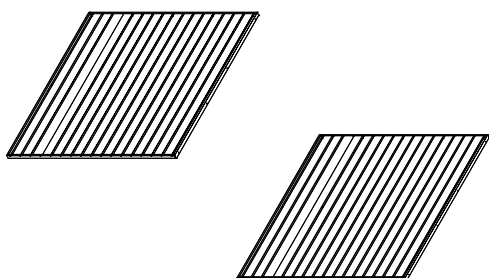

①

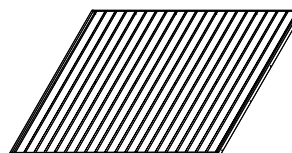

②

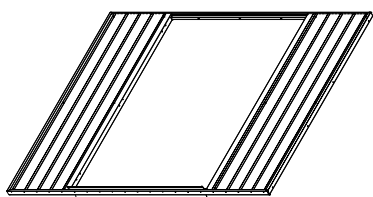

③

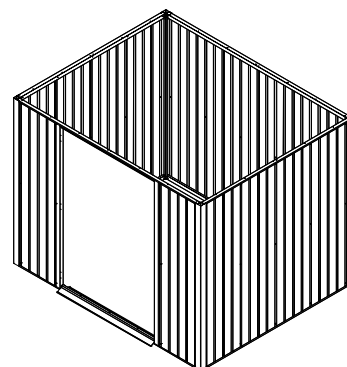

④

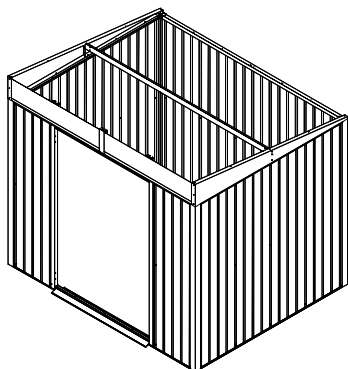

⑤

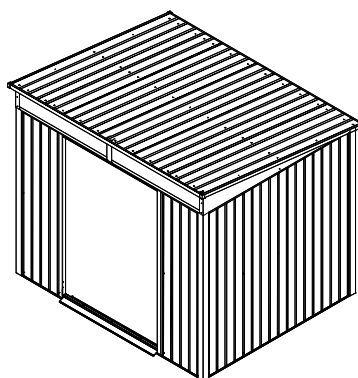

⑥

ASSEMBLY OVERVIEW

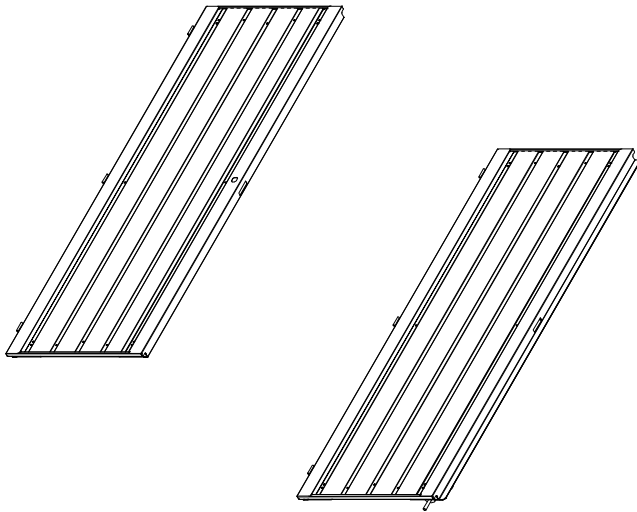



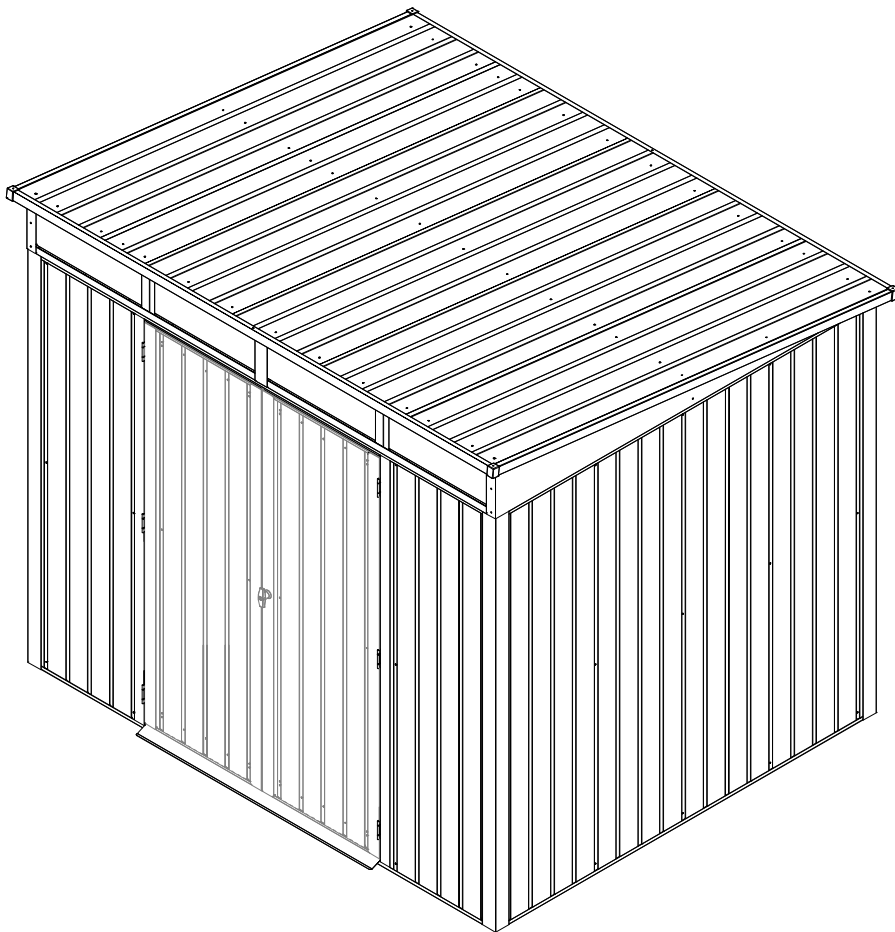

7





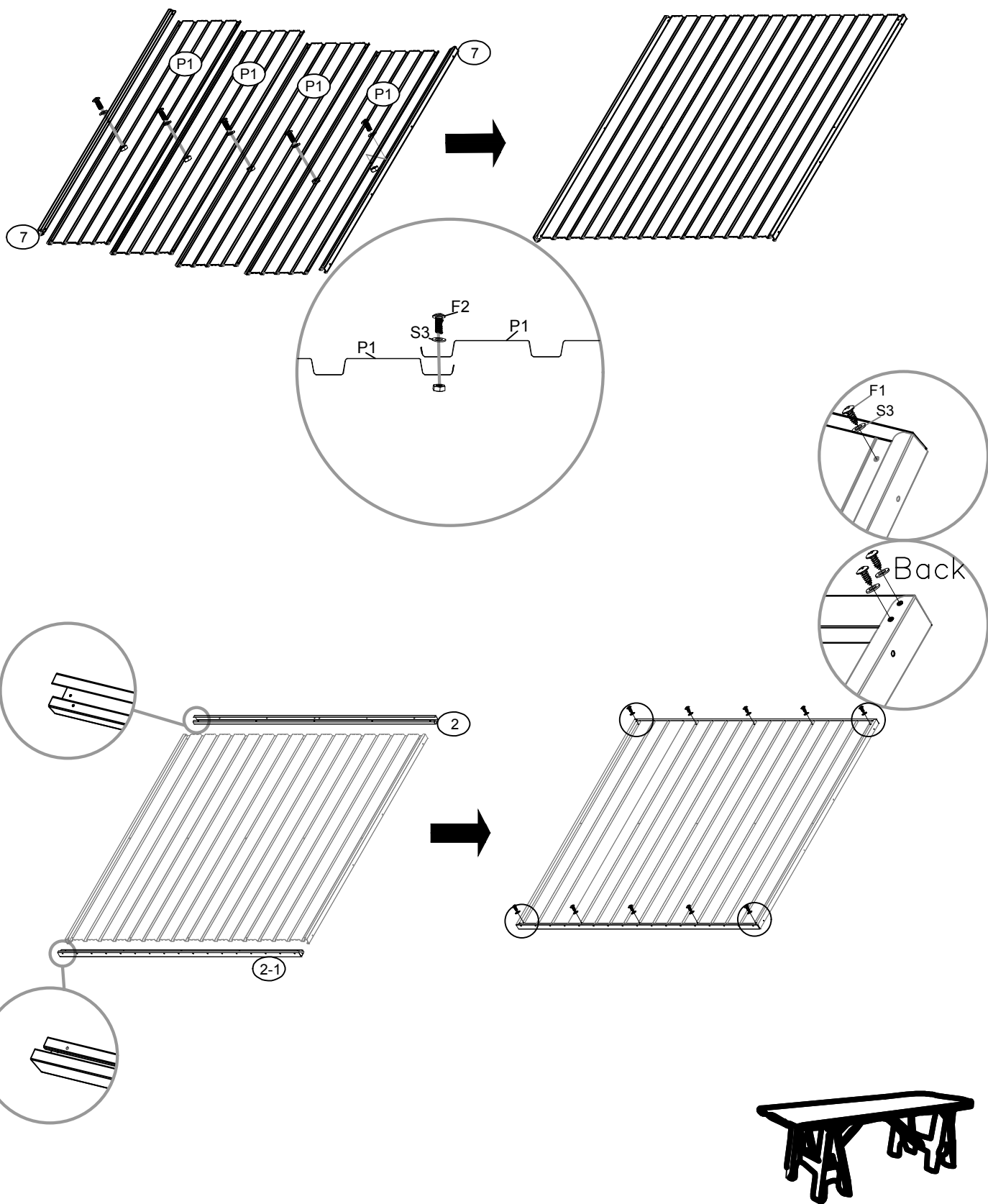

8

Step 1: Side Walls (2X)

NO.	PART	Qty.
2-1		2
2		2
P1		8
7		4



Step 2: Rear Wall

NO.	PART	Qty.
1-1		1
1		1
P1		5
7		2

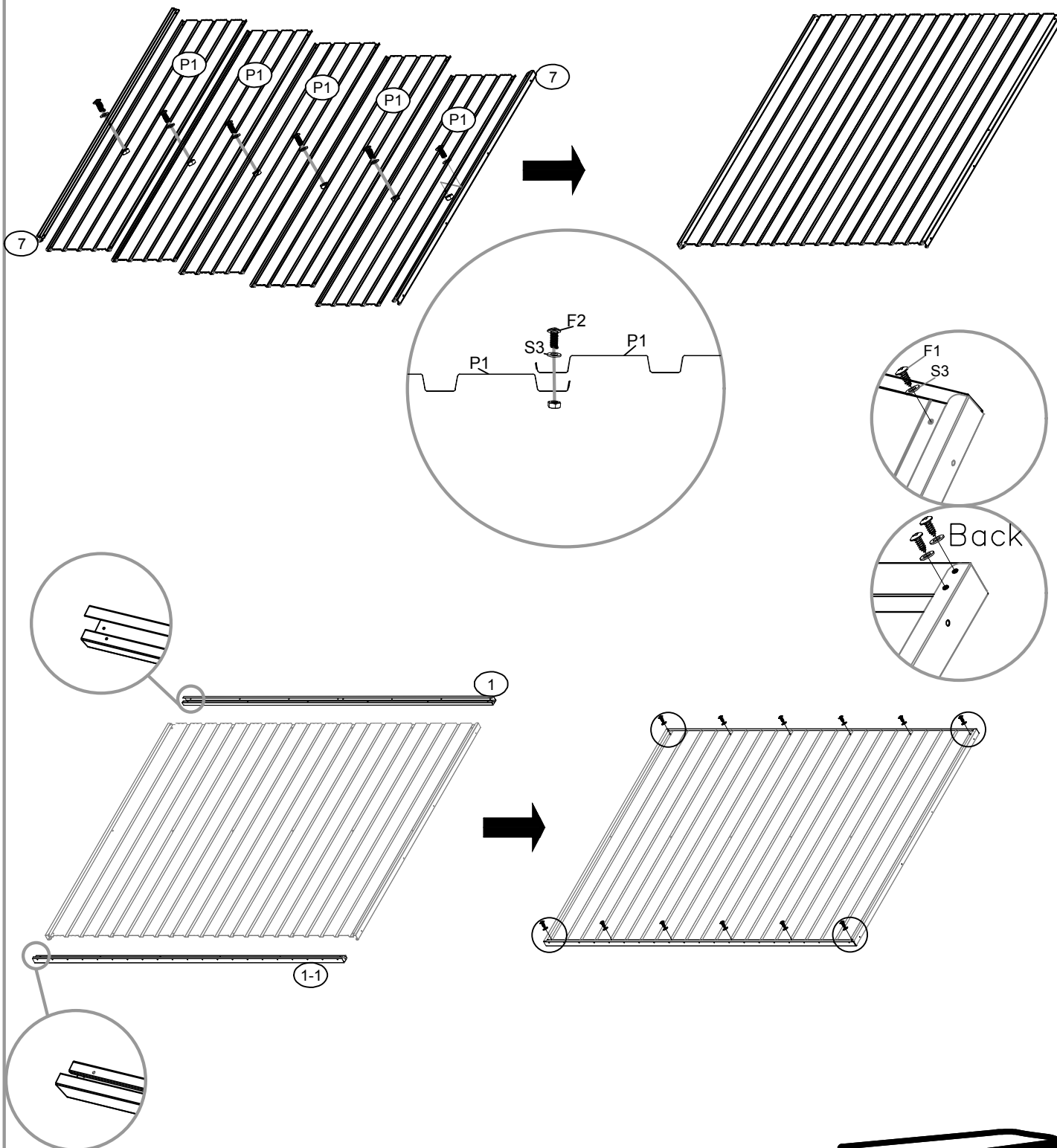

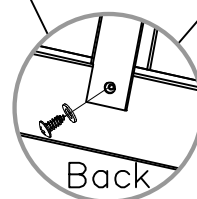
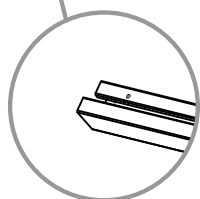
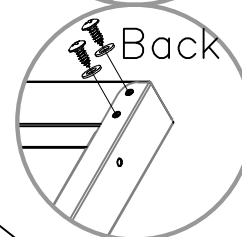
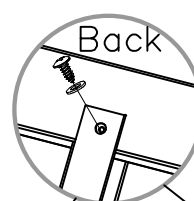
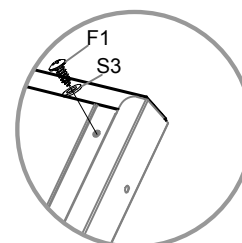
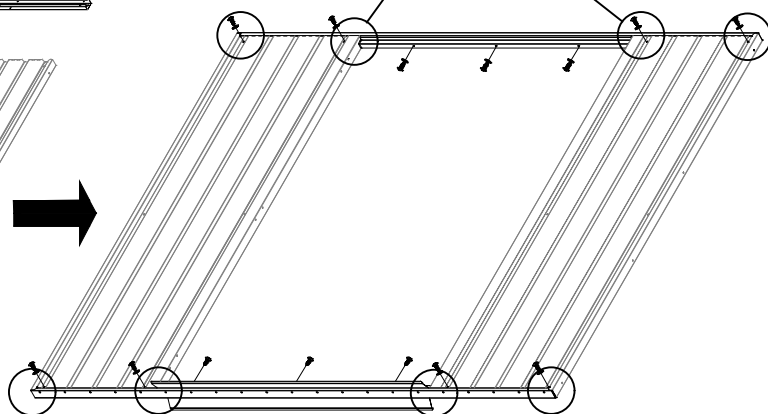
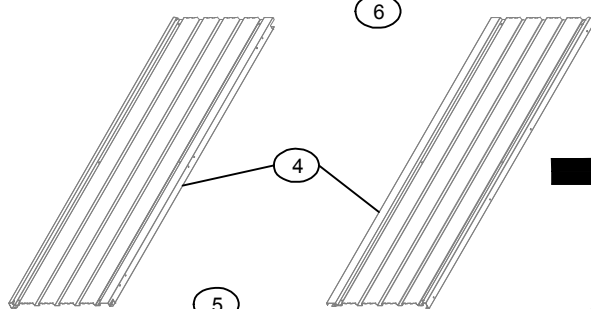
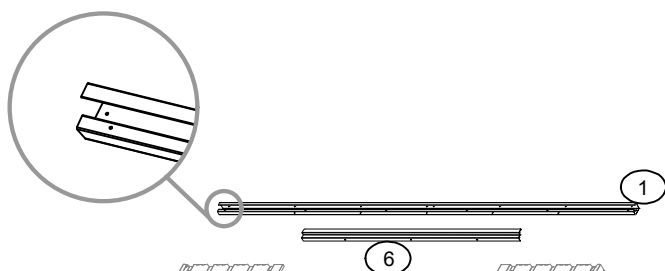
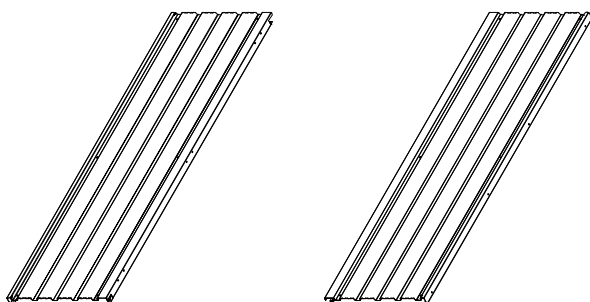
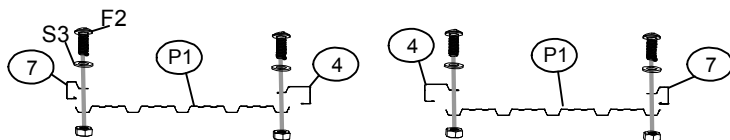

Step 3: Front Wall

NO.	PART	Qty.
P1		2
1-1		1
1		1
7		2
5		1
6		1
4		2



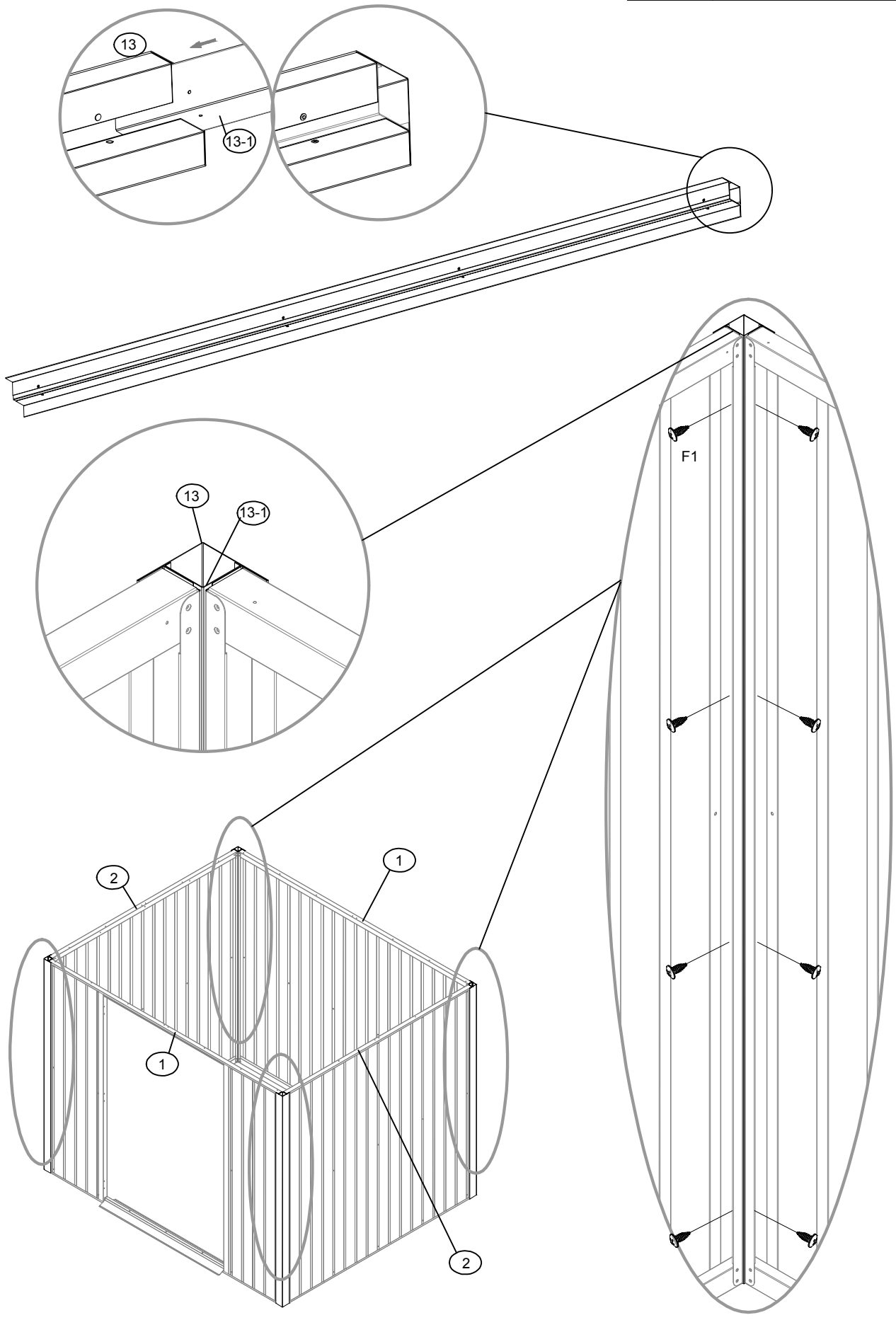

Step 4: Wall Assembly

NO.	PART	Qty.
13		4
13-1		4

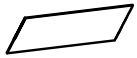

Step 5: Gables and windows

NO.	PART	Qty.
12L		1
12R		1
20		1
P5		2

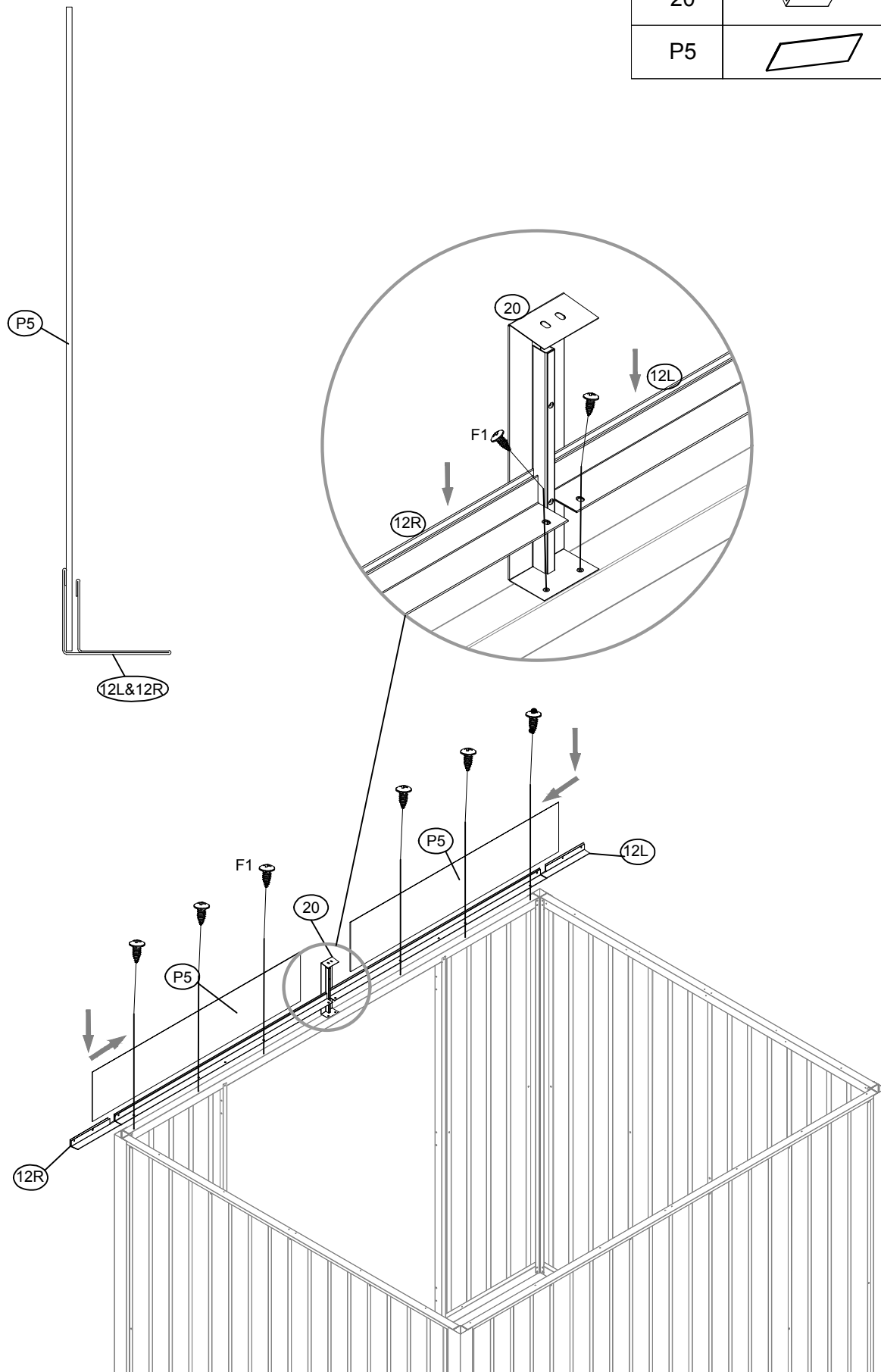



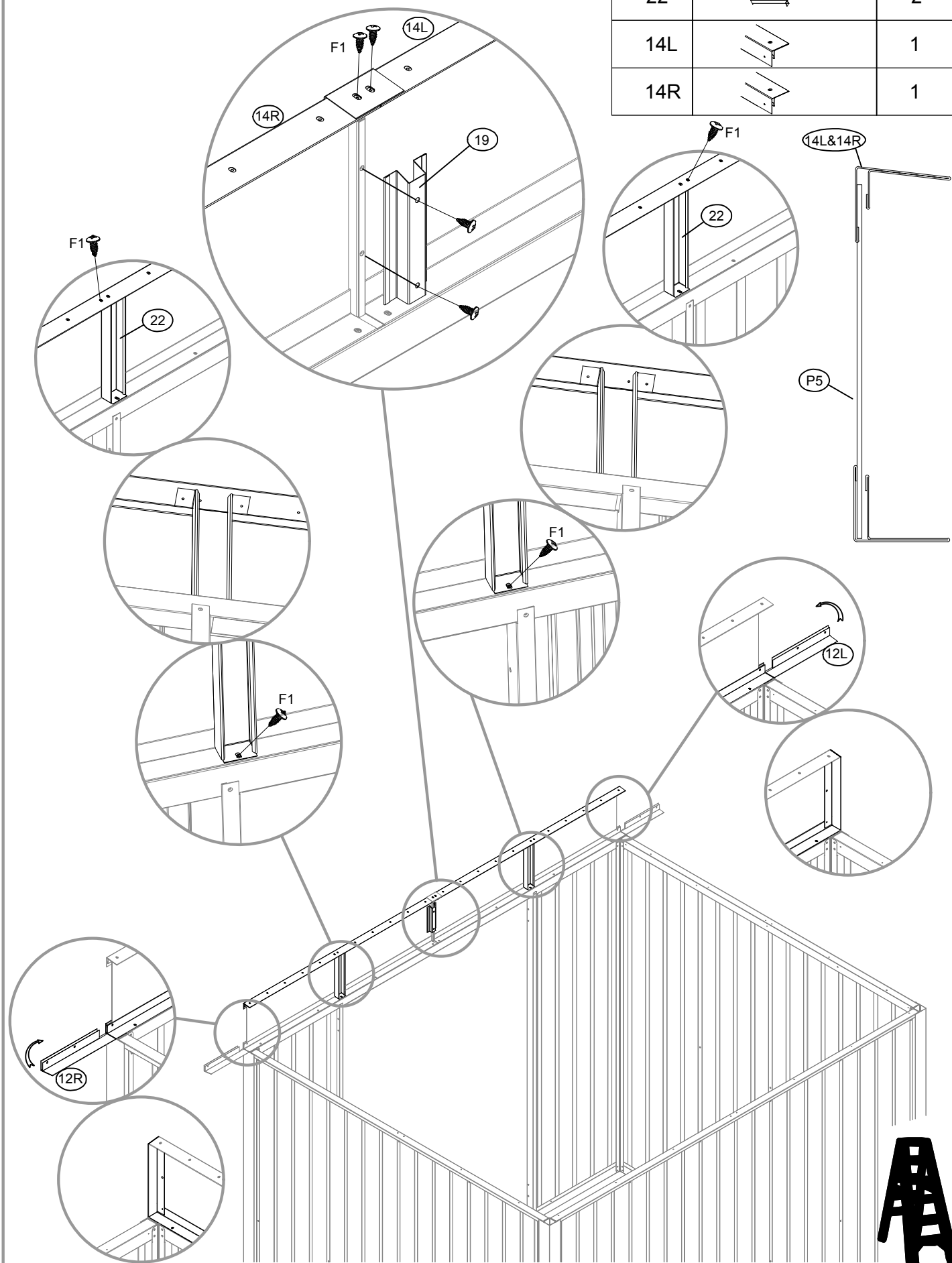

Step 5: Gables and windows

NO.	PART	Qty.
19		1
22		2
14L		1
14R		1



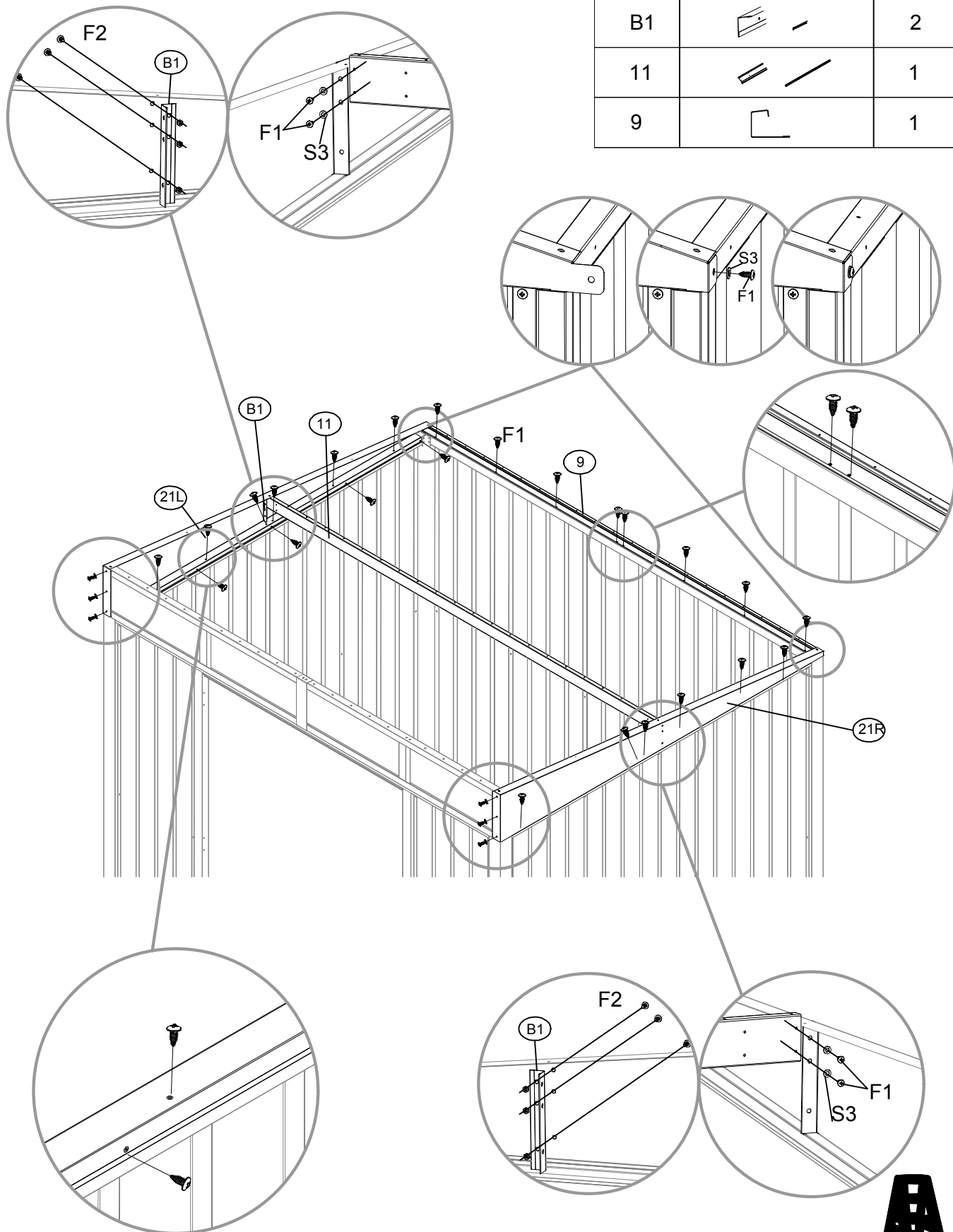

Step 5: Gables and windows

NO.	PART	Qty.
21L		1
21R		1
B1		2
11		1
9		1





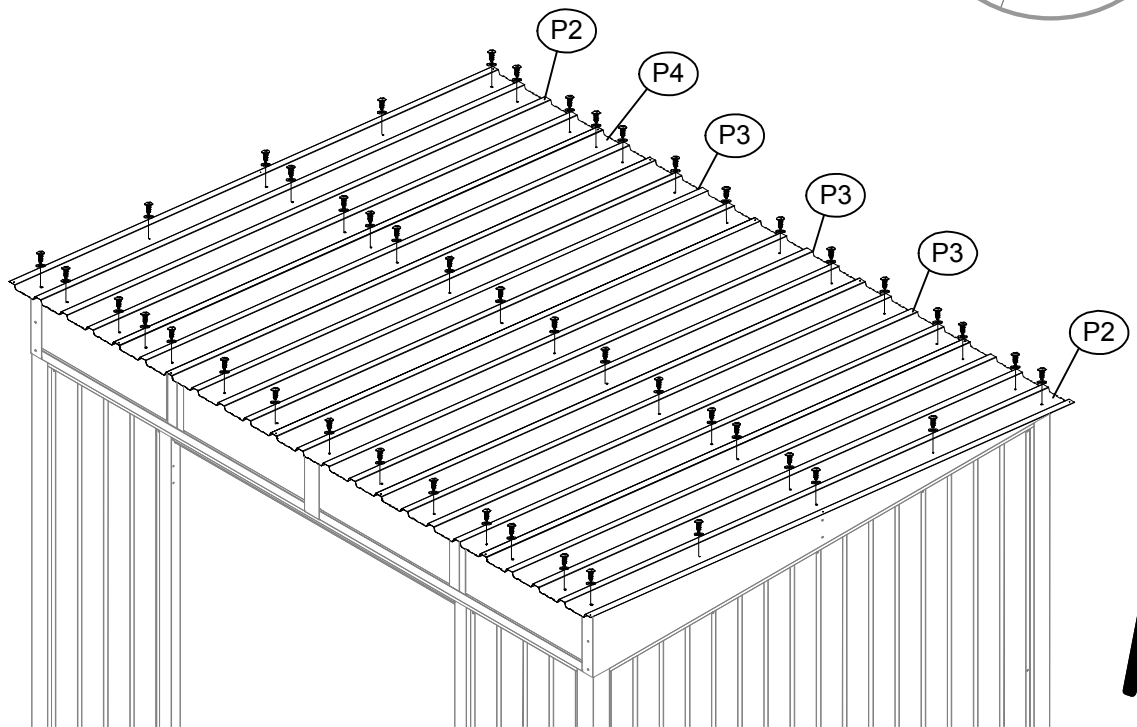
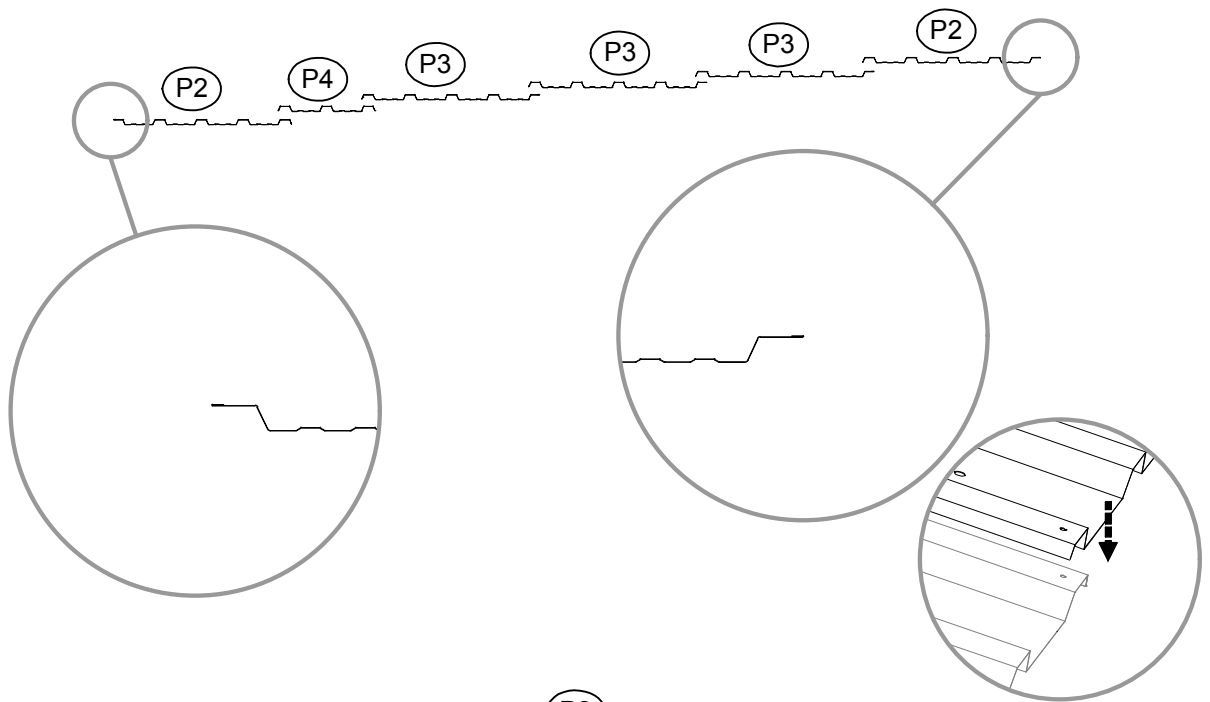

Step 6: Roof f installation

NO.	PART	Qty.
P2		2
P3		3
P4		1



Step 6: Roof f installation

NO.	PART	Qty.
17		1
17-2		2
10		1
GC		4
GS		2

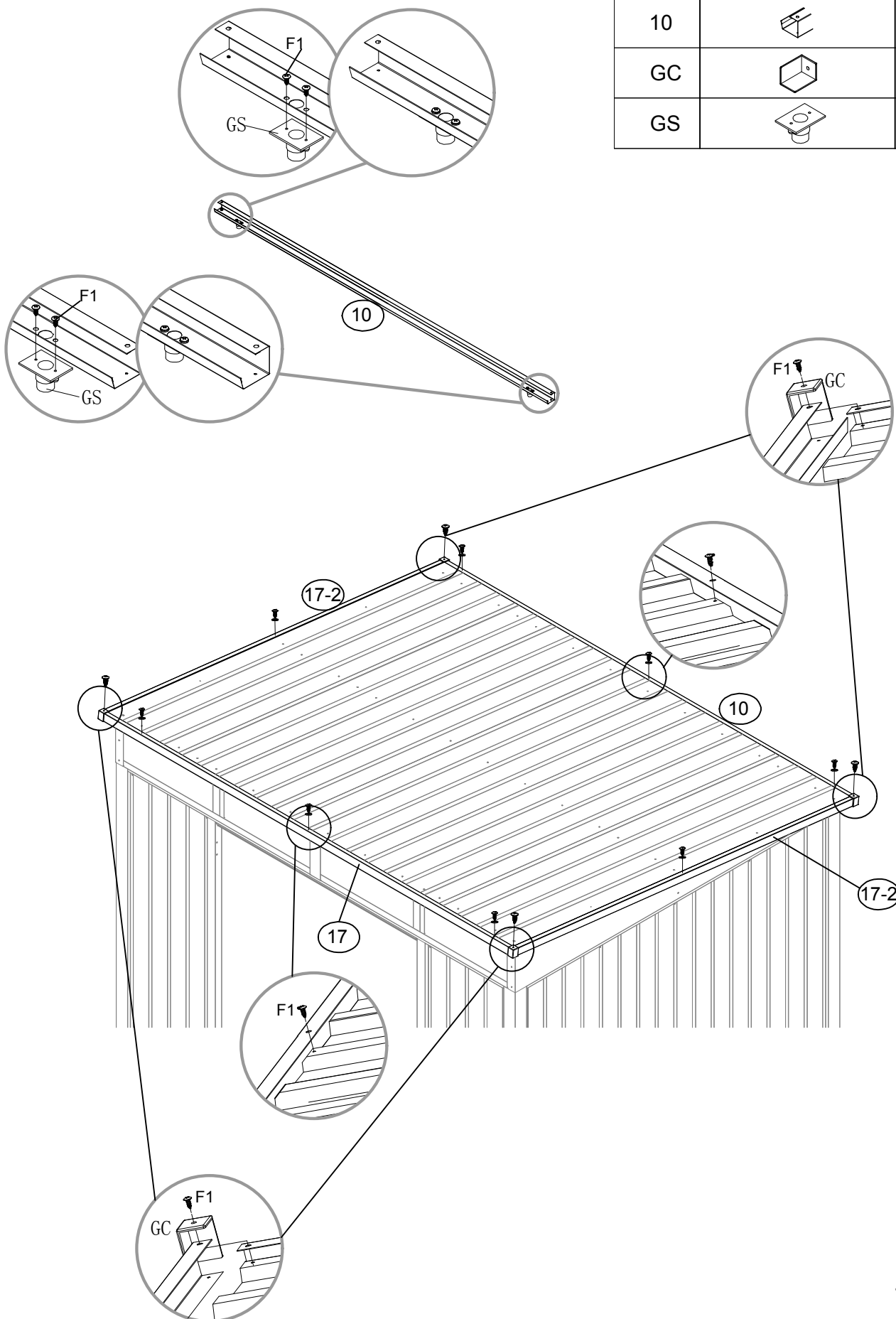

Step 7: Door Assembly

NO.	PART	Qty.
29		2
29-1		2
30		2
D1		1
31		1
32		1
40		1
41		1
B6		3

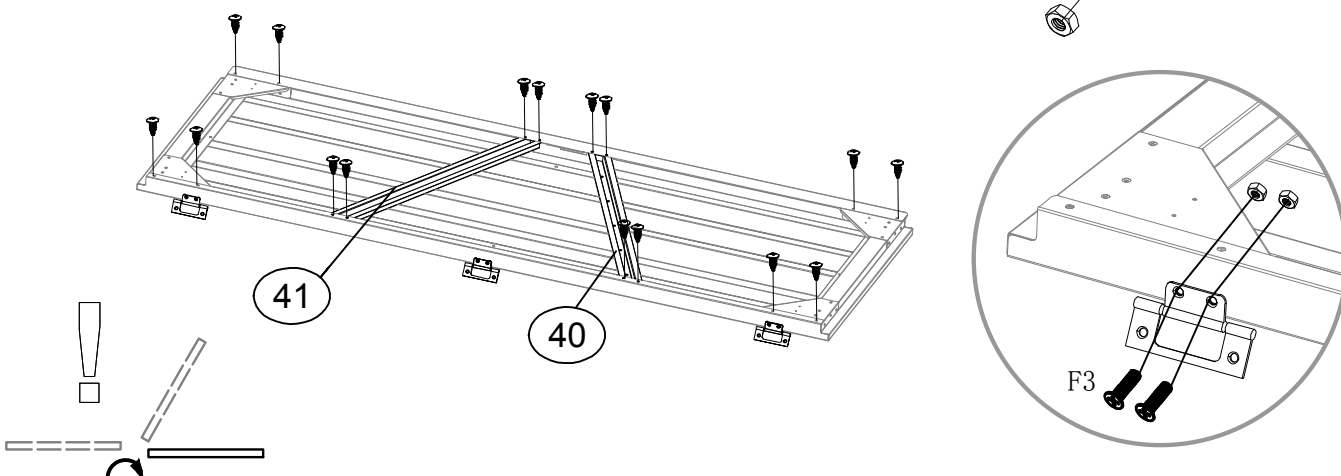
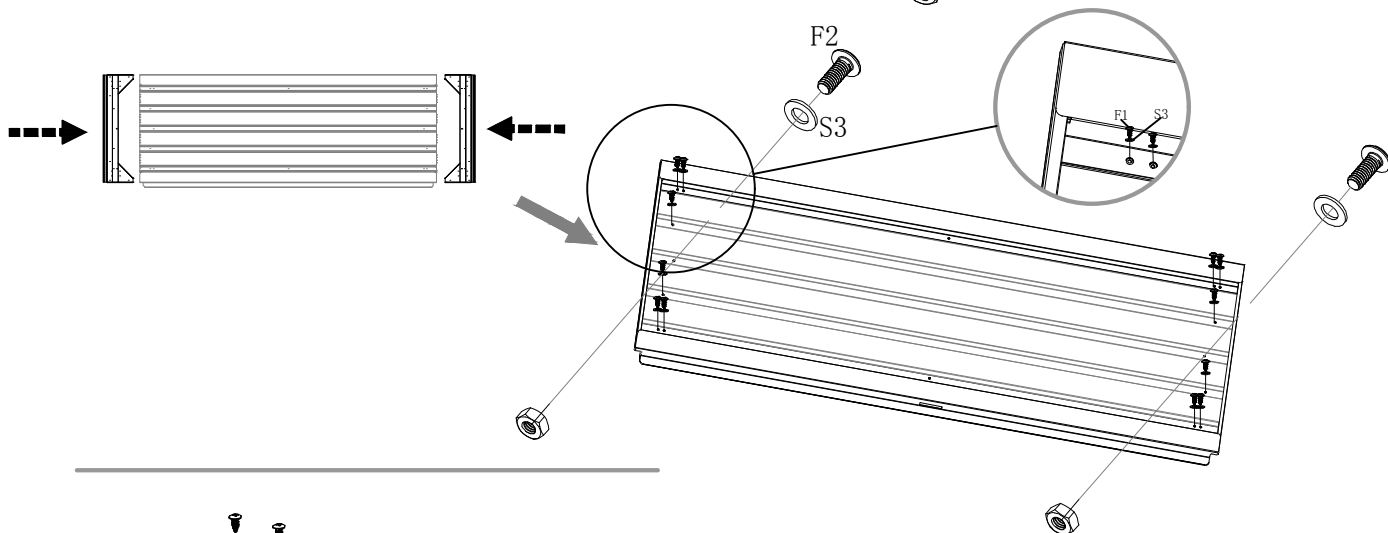
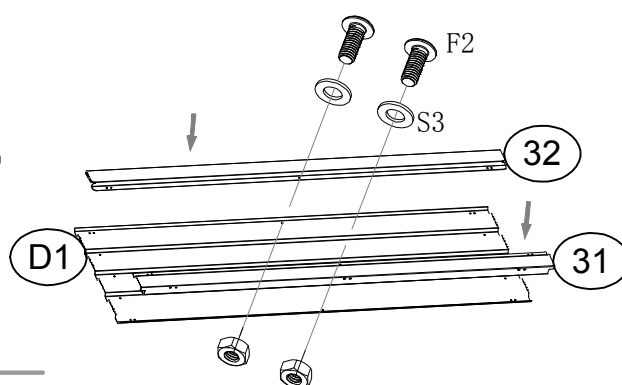
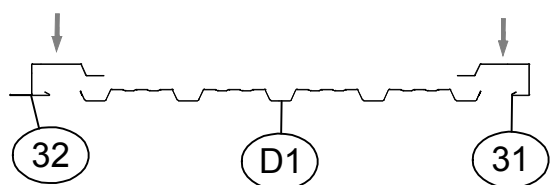
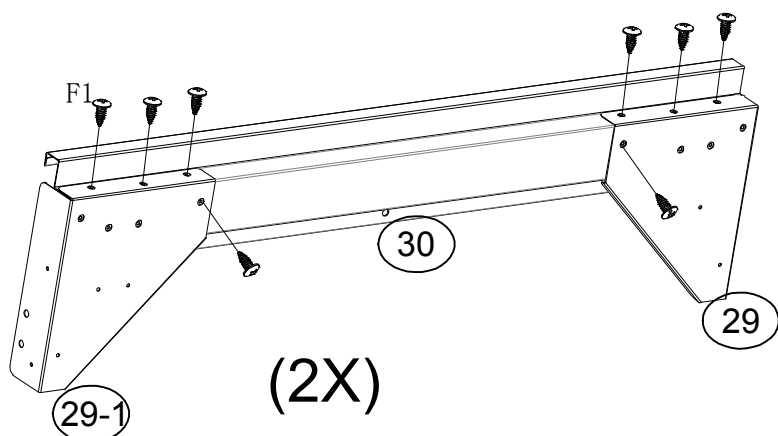

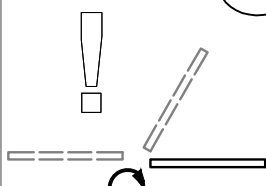
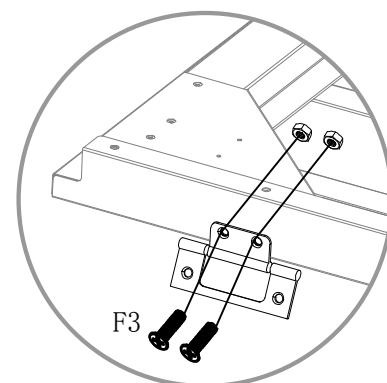
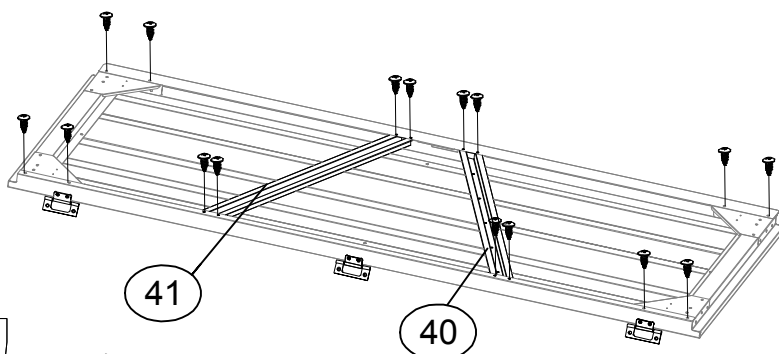
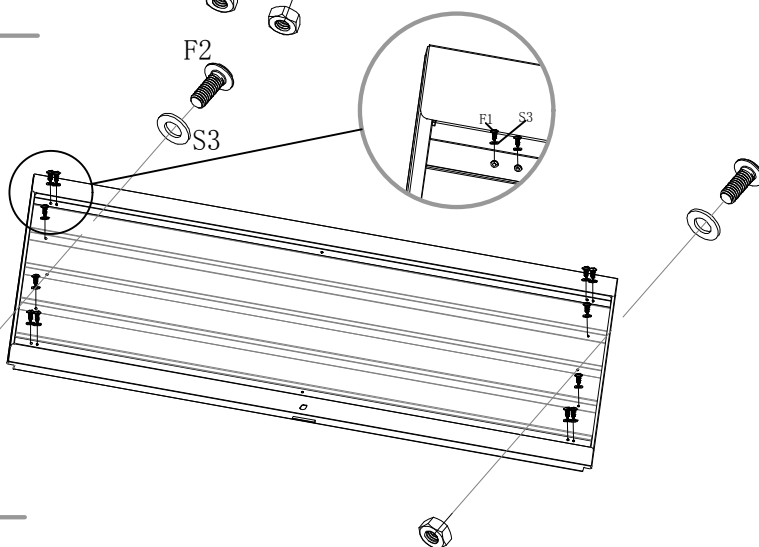
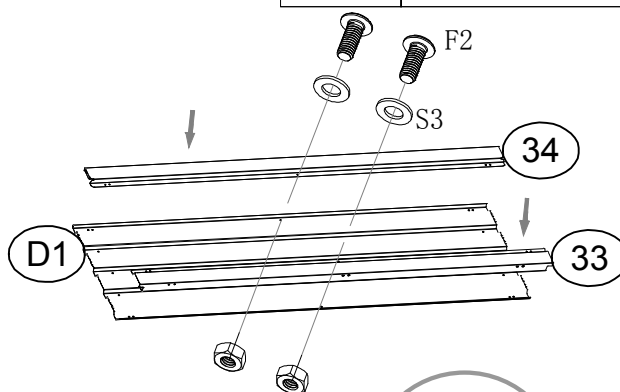
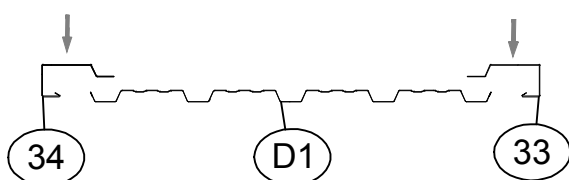
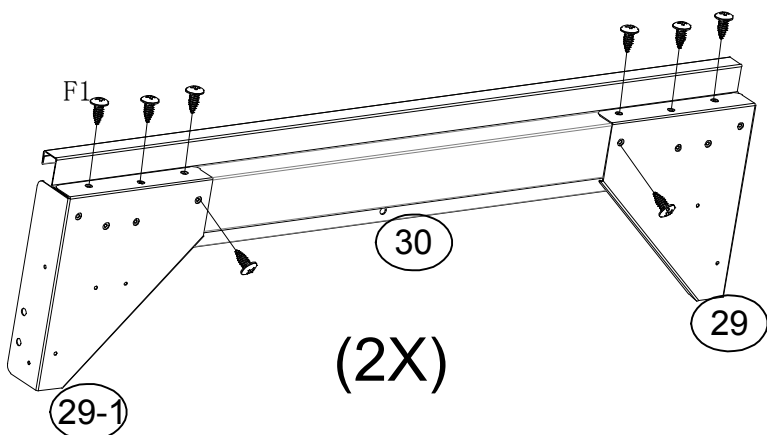

Step 7: Door Assembly

NO.	PART	Qty.
29		2
29-1		2
30		2
D1		1
33		1
34		1
40		1
41		1
B6		3



Step 8: Installing the door and lock

NO.	PART	Qty.
GB		1
H2		2

