

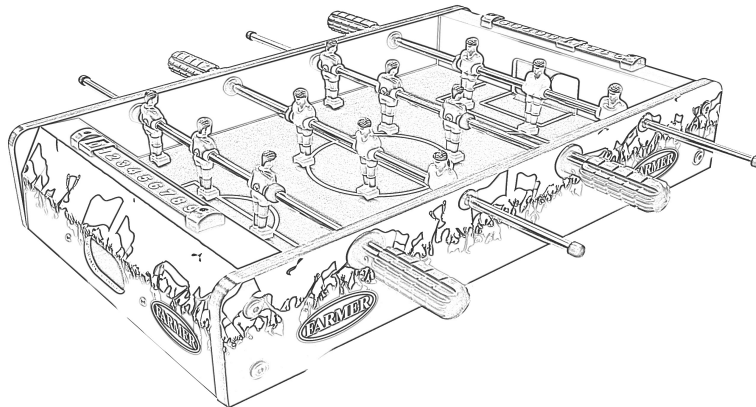

05004L
FARMER-XB



DE - TISCHFUSSBALLSPIEL

ACHTUNG! Nicht geeignet für Kinder unter 36 Monaten. Enthält kleine Bauteile und kleine Bälle, die verschluckt oder eingeatmet werden können. Erstickungsgefahr! Muß von Erwachsenen aufgebaut werden. Kinder sollten nur unter Aufsicht eines Erwachsenen spielen. Bitte diese Information aufbewahren. Lesen Sie alle Anleitungen in dieser Broschüre aufmerksam durch. Bei korrekter Benutzung dieses Spieltischs vermeiden Sie Beschädigungen und Verletzungen!

WERKZEUG FÜR DIE MONTAGE:

1 Kreuzschlitzschraubenzieher

FR - BABY-FOOT

ATTENTION! Ne convient pas aux enfants de 36 mois. Présence de petits éléments et petites balles risquant d'être avalés ou inhalés. Risque d'étouffement! Les enfants ne doivent jouer que sous la surveillance d'adultes. A monter par un adulte. Cette information à conserver SVP! Veuillez vous assurer de lire attentivement toutes les instructions incluses dans ce manuel. Une utilisation correcte de ce baby-foot peut éviter tout dommage et blessure!

OUTILS NECESSAIRES A L'ASSEMBLAGE:

1 tournevis cruciforme

Service Address:

CARROMCO GmbH & Co. KG
Mühlenweg 144, D-22844 Norderstedt/ Germany
Tel.: 49 (0) 1805 25 63 63

E-Mail service@carromco.com Website – www.carromco.com

MADE IN CHINA/ FABRIQUE EN CHINE / FABRICADO EN CHINA / FABBRICATO IN CINA



6+













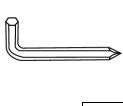

 1 x	ALLEN KEY CLÉ HEXAGONALE LLAVE ALLEN CHAIVE A BRUGOLA INBUSSLEUTEL Klucz Imbusowy IMBUSSCHLÜSSEL	 2 x	FOOTBALL BALLON PELONA DE FUTBOL PALLONE DA CALCIO VOETBAL Piłke FUßBALL	 8 x	SCREW VIS TORNILLO VITE SCHROEF Šruba SCHRAUBE
 4 x	SCREW VIS TORNILLO VITE SCHROEF Šruba SCHRAUBE	 4 x	SCREW VIS TORNILLO VITE SCHROEF Šruba SCHRAUBE	 2 x	END APRON BORDURE ARRIÈRE PANEL FRONTAL PIASTRA TERMINALE EINRAND Obrezeze tylne KOPFTEIL
 2 x	SIDE APRON BORDURE LATÉRALE PANEL LATERAL PIASTRA LATERALE ZIJPANEL Obrezeze Boczne SEITENPLATTE	 1 x	PLAYFIELD TERRAIN DE JEU CAMPO DEL JUEGO CAMPO GIOCO SPEELVELD Teren Zabawy SPIELFELD	 2 x	MANUAL SCORER A COMPTEUR MANUEL A MARCADOR MANUAL A SEGNAPUNTI MANUALE A MANUELE SCORETELLER A Wyniki A MANUELLER TORZÄHLER A
 8 x	BUMPER BUTOIR PARAGOLPES SOSTEGNO STOOTBLOKJE Gumowy odbijacz GUMMIPUFFER	 2 x	MANUAL SCORER B COMPTEUR MANUEL B MARCADOR MANUAL B SEGNAPUNTI MANUALE B MANUELE SCORETELLER B Wyniki B MANUELLER TORZÄHLER B	 4 x	MANUAL SCORER C COMPTEUR MANUEL C MARCADOR MANUAL C SEGNAPUNTI MANUALE C MANUELE SCORETELLER C Wyniki C MANUELLER TORZÄHLER C
 4 x	HAND GRIP POIGNÉE PUÑO IMPUGNATURA HANDVAT Uchwyt HANDGRIFF	 4 x	SAFETY END CAP EMBOUT DE PROTECTION TAPÓN DE SEGURIDAD CAPPUCCI DI SICUREZZA VEILIGHEIDSDOPJE Nakrętka zabezpieczająca SICHERHEITSKAPPE	 4 x	PLAYER ROD ASSEMBLY ASSEMBLÉE DE TIGE VARILLA DE JUGADOR ASTA A GIOCATORE SPELERSTANGEN Gracz Pręt SPIELERSTANGEN

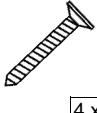
FIG. 1

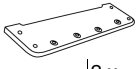
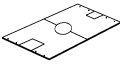
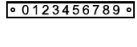

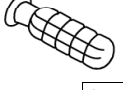

E1		2 x
E2		1 x
B1		4 x
A1		1 x

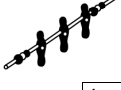
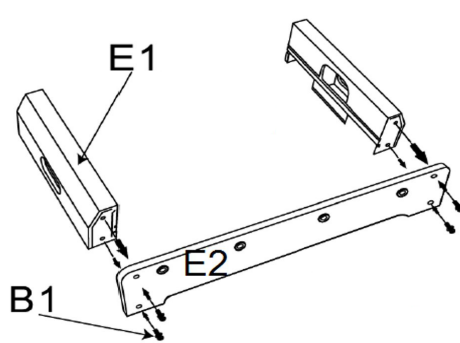
FIG. 2

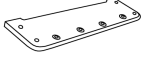
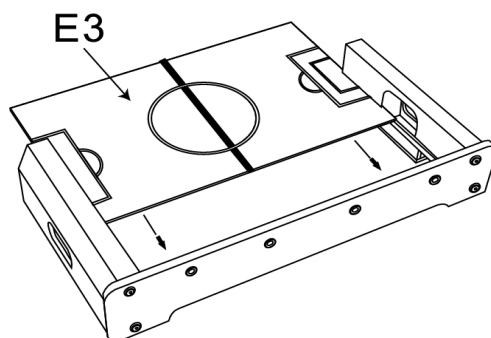

E3		1 x
-----------	---	------------

<p>FIG. 3</p>	<p>E5 8 x</p>
<p>FIG. 4</p>	<p>T1 1 x</p> <p>T2 1 x</p> <p>T3 1 x</p> <p>T4 1 x</p>
<p>FIG. 5</p>	<p>E2 1 x</p> <p>A1 1 x</p> <p>B1 4 x</p>
<p>FIG. 6</p>	<p>E9 4 x</p> <p>E10 4 x</p> <p>B3 4 x</p>
<p>FIG. 7</p>	<p>E4 2 x</p> <p>E7 2 x</p> <p>E8 4 x</p> <p>B2 4 x</p>